

Legacy Universal Unloader (UU1)

The Legacy Universal Unloader is unique in that it allows for height or width adjustments making it ideal for any pump. Exclusively available through Spraymart.

- 6 GPM
- 3500 PSI
- 195°F
- Forged brass body
- 1/2" NPT inlet
- 3/8" NPT outlet
- Stainless steel seat and low-friction, wear-resistant plunger
- 16.1 oz weight

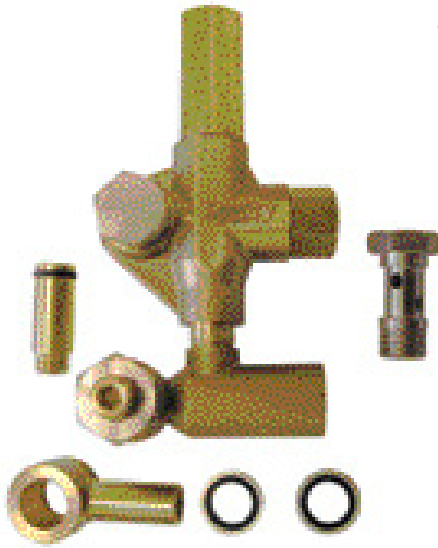

Part No.	Description
9.175-018.0	Universal Unloader

Patent Pending

Minimum Adjustment:

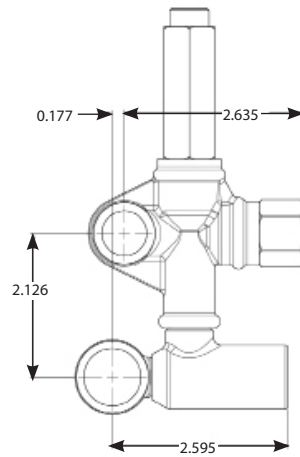

Maximum Adjustment:

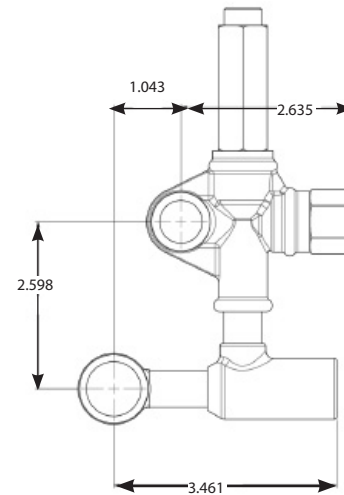

Adjusting inlet port



- 1.- Push up inlet port to make it shorter.
- 2.- Pull down inlet port to make it longer.



①



②

Adjusting horizontal sliding connector



- 1.- Turn the connector clockwise direction to make it shorter.
- 2.- Turn the connector counterclockwise direction to make it longer.



①



②

Automatic Pressure Regulator

Integral Regulator For Admiral Pumps: WE - WG - WEL - XLS - XLE - XLG bolt on for Admiral and Legacy Pumps. Trapped pressure regulator specifically designed for use on the Admiral plunger pumps. Integral inlet, bypass and outlet eliminates the need for bypass hose.



8.703-401.0

- 6 GPM
- 3200 PSI
- 195°F
- Forged brass body
- 3/8" MPT outlet
- Stainless steel plunger & seat valve
- 29 oz weight

Part No.	Orig. No.	Description	Inlet
8.703-401.0	106020	APR-Brass/ Black 3/8"	
9.802-365.0	106022	APR-Brass/ Black 1/2"	
8.900-760.0	109139	Seal Repair Kit - 3/8"	
8.900-761.0	109139X	Seal Repair Kit - 1/2"	
8.900-762.0	109140	Valve Seat Repair Kit	

Regulators / Unloaders



Basic Valves. Premium Performance.



- Forged brass body
- Stainless steel seat & piston
- 3/8" MPT inlet, outlet & bypass
- 200°F

520 Regulator / Unloader

- Rated @ 2000 PSI
- 13 oz weight
- Tested up to 2400 PSI
- 8 GPM

540 Regulator / Unloader

- Rated @ 2600 PSI
- 15 oz weight
- Tested up to 2800 PSI
- 8 GPM

560 Regulator / Unloader

- Rated @ 3200 PSI
- 15 oz weight
- Tested up to 3400 PSI
- 8 GPM

Repair Kits

- For use with 520, 540, and 560 Regulator/Unloaders



Part No.	Original No.	Description
8.712-588.0	462320	520 w/o Knob
8.712-589.0	462320K	520 w/ Knob
8.712-590.0	462330	540 w/o Knob
8.712-591.0	462330K	540 w/ Knob
8.712-596.0	462340K	560 w/ Knob
8.704-003.0	109177	Seal Repair Kit
8.704-004.0	109178	Valve Seat Repair Kit

Regulator/ Unloader 580



Single Inlet.



- 8 GPM
- 3600 PSI
- 200°F
- 3/8" MPT inlet & outlet, 1/4" FPT bypass
- Adjustable pressure setting nut
- Heavy-duty forged brass body
- Stainless steel ball & valve seat
- High temperature Viton seals
- Adjustable upper pressure limit lock

Part No.	Original No.	Description
8.712-733.0	463350	w/o Knob
8.712-734.0	463350K	w/ Knob
8.703-951.0	109060	Seal Repair Kit
8.703-953.0	109062	Valve Seat Repair Kit

VRT3 Unloader Valve



- Forged brass body
- Stainless internals
- Up to 4500 PSI
- 200°F
- 8.0 GPM
- 3/8" in-out/bypass

Part No.	PSI	Spring
8.750-297.0	2320	Yellow
8.750-298.0	3650	Blue
8.750-299.0	4500	Black
8.750-300.0	4500 w/EZ Start	Black
8.750-955.0	4500 w/Switch, W/O Knob	
8.750-956.0	4500 w/Switch, W/ Knob	
8.750-709.0	Repair Kit, VRT3, 2320/3630 PSI	
8.750-710.0	Repair Kit, VRT3, 4500 PSI	
9.802-694.0	Repair Kit, Old Style VRT 605, 606, 607	

UNLOADERS

Pulsar Unloaders



- Pulsar 3 blue rated 3200 PSI – Max 3650 PSI
- Pulsar 3 white rated 1400 PSI – Max 1750 PSI
- Pulsar 280 HP rated 4050 PSI – Max 4350 PSI
- 195°F
- 8 GPM
- All stainless steel valves
- Pressure actuated
- Forged body
- 3/8" FPT inlet, outlet
- Two 3/8" FPT bypass ports

Part No.	Original No.	Description
8.712-650.0	462650	Pulsar 3 (Blue) w/ Knob
8.712-651.0	462651	Pulsar 3 (Blue) w/o Knob
8.712-653.0	462654	Pulsar 3 (White) w/ Knob
8.712-731.0	463150	Pulsar 280 HP
8.704-462.0	111100	Repair Kit – Pulsar 3
9.802-004.0	111375	Repair Kit – 280 HP

VB7 Regulator/Unloader



Fits CAT 4SF pumps and other pumps; 7.8 GPM – 3600 PSI max pressure.



- Rated pressure: 3200 PSI
- 200°F
- 3/8" MPT inlet, 1/4" FPT gauge port
- 3/8" FPT outlet & bypass
- 19.7 oz weight

Part No.	Original No.	Description
8.712-741.0	463670	w/o Knob
8.904-580.0	463670K	w/ Knob
8.704-488.0	111175	Repair Kit
8.712-735.0	463600	Knob Only

VB130 Regulator/Unloader



Fits CAT 2SF pumps and other pumps; 6.6 GPM – 2600 PSI max pressure.



- Rated pressure: 2300 PSI
- 200°F
- 3/8" MPT inlet & outlet
- 3/8" FPT bypass
- Stainless steel plunger
- Stainless steel valve seat
- 14.7 oz weight

Part No.	Original No.	Description
8.712-739.0	463660	w/o Knob
8.904-579.0	463660K	w/ Knob
9.802-006.0	111150	Repair Kit
8.712-735.0	463600	Knob Only

Regulator/Unloader 21 Gallon



- VB80/280 rated @ 4500 PSI
- VB80/150 rated @ 2250 PSI
- 200°F
- Pressure actuated
- Forged brass body
- Stainless steel plunger & seat
- 1/2" FPT in-out-bypass
- 45 oz weight

Part No.	Orig. No.	Description
8.715-459.0	462655	VB80/280 - Blue Spr
8.712-657.0	462657	VB80/150 - White Spr
8.704-530.0	111300	Repair Kit

VB75 / VB135



The VB75 is an integrated unloader for INTERPUMP/GENERAL pumps with 7.8 GPM – 3600 PSI max pressure. The VB135 fits Interpump "WW" Series Pumps and General "TT" Series Pumps with 6.5 GPM – 2600 PSI max pressure.



- Rated pressure: 3200 PSI
- 200°F
- 1/2" MPT inlet, 1/4" FPT gauge port
- 3/8" FPT outlet & bypass
- 19.7 oz weight

- Rated pressure: 2300 PSI
- 200°F
- 3/8" MPT inlet, 1/4" FPT outlet
- Stainless internals
- Forged brass body
- 22.9 oz weight

Part No.	Original No.	Description
VB75		
8.712-742.0	463672/462646	Series 44 (EZ) & 47 pumps (W151)
8.704-488.0	111175	Seal Kit
8.712-735.0	463600	Knob Only
VB135		
8.712-659.0	462659	VB 135
8.712-735.0	463600	Knob Only
9.802-006.0	111150	VB 135 Repair Kit

VB350/4 Unloader



Bigger. Stronger. Faster - 5600 PSI



- 10.5 GPM
- Rated 5100 PSI
- Max 5600 PSI
- 195°F max
- Forged bronze body
- 31 oz weight
- Stainless steel plunger & valve seat
- 3/8" FPT outlet & bypass
- 1/2" F bypass
- 3/8" MPT inlet, 1/4" gauge port

Part No.	Original No.	Description
9.802-360.0	463680K	Unloader Red Knob
8.704-499.0	111200X	Repair Kit Old VB 350
9.800-106.0	111901	Repair Kit - Red Knob Version

Automatic Pressure Compensating Unloader Valves VB10 / VB9



7.8 GPM - 3600 PSI



- Rated 3200 PSI
- 194°F
- Reduces trapped pressure to 25% of operating pressure when unloading; allows easier gun trigger pull
- Instant pressure response
- Hex-shaped non-stick check valve
- 3/8" in/out/bypass
- Brass valve body/stainless ball & seat
- Knob included
- VB9 - Panel mountable

Part No.	Orig. No.	Description
8.712-736.0	463650	VB9 w/ Knob
8.715-462.0		VB9 w/ Knob & Pressure Switch
8.712-745.0	463675	VB10 w/ Knob
8.704-548.0	111336	Repair Kit VB9
8.704-561.0	111400	Repair Kit VB10
8.901-056.0	111401	Seal Kit VB10

8.715-462.0

VB200 / 150 High Volume Unloader



- 52.5 GPM
- Forged bronze body
- Large plastic knob (removable)
- Lock nut on pressure adjustment
- 2175 PSI
- 194°F
- 1" FPT Inlet, outlet & bypass
- Two 5/16" – 18 bolt mounting ports
- 73.5 oz weight

Part No.	Original No.	Description
8.712-754.0	463714	VB 200/150 w/o Knob
8.712-755.0	463715	VB 200/150 w/ Knob
8.704-583.0	111550	Repair Kit

VB80/400 Stainless Steel Unloader



21 GPM – 6200 PSI.



- Rated 5800 PSI
- Forged stainless steel body
- 195°F
- All stainless steel valve parts
- Viton seals
- 1/2" FPT inlet, outlet & bypass

Part No.	Original No.	Description
8.712-656.0	462656	VB 80/400
9.802-007.0	111340	Repair Kit

Hypro-Style Unloader



- All rated at 5 GPM
- Pressures from 400 to 1500 PSI
- 180°F
- Buna-N seals
- 3/8" MPT inlet & outlet
- 8 oz weight

Part No.	Original No.	Pressure	Bypass
8.712-689.0	462739	200-500	1/4" FPT
8.712-690.0	462740	400-1000	1/4" FPT
8.712-691.0	462743	800-1500	1/4" FPT
8.712-692.0	462745*	400-1000	
8.712-693.0	462748*	800-1500	
8.722-643.0	H34300223	Repair Kit for All	

*Bypass port not threaded, Closed Coupled

"K" Series Pressure Regulators Kits



Repair Kits for All K3, K5, K7 and K9 models

Part No.	Original No.	Description
8.702-850.0	103061B	K3 Rebuild Kit
8.702-847.0	103058B	K5 Maintenance Kit
8.702-849.0	103060B	K5 Rebuild Kit
8.705-045.0	140070	K5 Back Nut 3/4" NPT
8.702-858.0	103070B	K7 Repair Kit
8.702-911.0	103121B	K9 Repair Kit

"K" Series Pressure Regulators



Unloaders relieve line pressure in bypass mode.



K3 - 0-1500 PSI

- 3/8" FPT Inlet
- 165°F
- 1/2" FPT B

Part No.	Original No.	Model	GPM	Outlet
K3				
8.712-603.0	462530A	K3.0	2.10-2.90	3/8" M
8.712-605.0	462531A	K3.1	2.90-4.22	3/8" M
8.712-607.0	462532A	K3.2	4.22-5.55	3/8" M
8.712-609.0	462533A	K3.3	5.00-6.50	3/8" M
8.712-604.0	462530E	K3.0	2.10-2.90	1/2" M
8.712-606.0	462531E	K3.1	2.90-4.22	1/2" M
8.712-608.0	462532E	K3.2	4.22-5.55	1/2" M
8.712-610.0	462533E	K3.3	5.00-6.50	1/2" M

K5 - 1000-3000 PSI



K7 - 0-3000 PSI

Part No.	Original No.	Model	GPM	Outlet
K5				
8.712-611.0	462551A	K5.1	2.90-4.22	3/8" M
8.712-613.0	462552A	K5.2	4.22-6.60	3/8" M
8.712-615.0	462553A	K5.3	6.60-10.83	3/8" M
8.712-612.0	462551E	K5.1	2.90-4.22	1/2" M
8.712-614.0	462552E	K5.2	4.22-6.60	1/2" M
8.712-616.0	462553E	K5.3	6.60-10.83	1/2" M

NOTE: 1) Use #140070 Back nut on bypass nipple when mounting 1/2" bypass line on K3 & K5's. 2) Use restricted (.156 - .225 ID) orifice in bypass line for smoother operation/pressure balancing.

- 3/8" FPT
- 165°F

Part No.	Original No.	Model	GPM	Outlet
8.712-617.0	462570	K7.0	2.11-2.90	3/8" M
8.712-618.0	462571	K7.1	2.90-4.22	3/8" M
8.712-619.0	462572	K7.2	4.22-6.60	3/8" M
8.712-620.0	462573	K7.3	6.60-10.8	3/8" M



ZK1 - 0-3600 PSI

- 2.3-10.8 GPM
- 3/8" inlet BSP-F
- 165°F

Part No.	Original No.	Model	Outlet / Bypass
8.712-602.0	462526	2K138	3/8" BSP-M
8.712-601.0	462525	ZK1	1/2" BSP-M



K9 - 0-5800 PSI

- 1/2" FPT
- 165°F

Part No.	Original No.	Model	GPM	Outlet
8.712-621.0	462574	K9	13.2	1/2" M

VBA35/VB55 Unloader Valves for Legacy HD Pumps



- 6.6 GPM
- 3500 PSI



Part No.	Description
VBA35 for Legacy HD models	
9.803-899.0	GG, GD, GE
9.803-900.0	GM, GS
• 8 GPM • 3650 PSI	
Part No.	Description
VB55 for Legacy HD models	
9.802-363.0	GM, GS

UNLOADERS

Control Set "W" Series / Integrated Regulator / Unloader



Designed exclusively to fit INTERPUMP and GENERAL pumps.

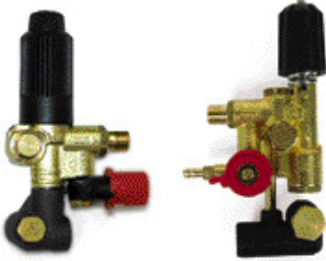

- Mounts directly on pump inlet and outlet; internal bypass loop
- Pressure actuated: "Instant - On"
- 3/8" MPT outlets
- Integrated injector - optional
- Pressure and flow engineered for specific pump models

Part No.	Orig. No.	Model	GPM	Fits PSI	Pump
"W" Series Unloaders					
8.712-638.0	462636	W1	4.00	1600	W905
8.712-640.0	462639	W1-L	4.00	1600	W99
8.712-643.0	462643	W2	5.56	3000	W997
8.712-644.0	462644	W2-L	5.56	3000	W201
8.702-883.0	103093B	W2/W2L Rebuild Kit			
8.702-888.0	103098B	W1/W1L Rebuild Kit			

Part No.	Orig. No.	Model	GPM	Fits PSI	Pump
"W" Series Unloaders with Injectors					
8.712-637.0	462635	W1-0	2.1-2.9	1600	W907
8.712-641.0	462640	W1L-1	3.0-4.0	1600	W99
8.712-642.0	462642	W2-1	2.9-4.0	3000	W997
8.712-645.0	462645	W2L-1	2.9-4.0	3000	W201
8.712-647.0	462647	W2L-2	4.2-5.5	3000	WS202
8.702-884.0	103094B	Injector Maintenance Kit			

HM Regulator / Unloader



- Excess flow is bypassed to maintain selected pressure
- Will operate on single or multiple gun systems
- Brass body - Stainless steel valve & seat
- 3/8" FPT inlet
- 3/8" MPT outlet
- 3/8" FPT bypass
- Flow range - 1.4 to 10.8 GPM
- Pressure adjustable 0-3000 PSI

Part No.	Original No.	Description
8.712-622.0	462575	HM Regulator/Unloader
8.702-860.0	103072B	Repair Kit

YU - High Volume Unloader



- 21 GPM
- 1/2" FPT inlet, outlet
- 2 - 1/2" FPT bypass ports
- 200°F
- Forged brass body
- SS internals
- YU-2121 Yellow Spring
- 2450 PSI
- 2200 PSI rated pressure
- YU-2140 Green Spring
- 4350 PSI
- 4050 PSI rated pressure

Part No.	Original No.	Spring
8.712-631.0	462628	2121 Yellow
8.712-632.0	462629	2140 Green
9.802-007.0	111340	Repair Kit

ST-261 Regulator / Unloader



- 8 GPM
- 0-3600 PSI regulation
- Forged brass body
- Stainless steel plunger & seat
- Viton seals
- 22.5 oz weight
- 180°F temperature rating

ST-261 Standard



Part No.	Original No.	Description
8.712-681.0	462690	ST-261 STD
8.900-156.0	088211X	Seal Kit
8.701-627.0	088209	Repair Kit "B"
8.701-650.0	088466	Outlet Check Kit "A"

ST-261/S Unloader with Bypass Switch



- Switches at full bypass flow
- 10 Amp, 110/230V
- Wired N/C (may be wired N/O)

Part No.	Original No.	Model
8.712-685.0	462695	ST-261/S
8.701-647.0	088422	Switch Seal Kit

ST-261/I Unloader with Chemical Injector



Part No.	Orig. No.	GPM	Model
8.712-682.0	462691	0.0-2.4	ST-261/I-1
8.712-683.0	462692	2.4-3.5	ST-261/I-2
8.712-684.0	462693	3.5-5.5	ST-261/I-3
8.900-159.0	088260X		Injector Repr w/o Barb
8.701-648.0	088424		Injector Repr w/ Barb

ST-261/SI Unloader with Switch and Injector



- Switches at full bypass flow
- 10 Amp, 110/230V
- Wired N/C (may be wired N/O)

Part No.	Orig. No.	GPM	Model
8.712-686.0	462696	0.0-2.4	ST-261/SI-1
8.904-576.0	462697	2.4-3.5	ST-261/SI-2
8.904-577.0	462698	3.5-5.5	ST-261/SI-3

ST-261 Bypass Switch only



- Field mountable
- 10 Amp @ 115/230V
- Switches at full bypass flow
- Wired N/C (may be wired N/O)

Part No.	Orig. No.	Description
8.712-629.0	462626	Switch Assy Complete
8.701-642.0	088272	Micro Switch Only
8.701-647.0	088422	Seal Kit - Micro Switch

ST-230 Regulator/Relief Valve



- 8 GPM
- Complete pressure regulation 0-3600 PSI
- 200°F
- 1/4" FPT Inlet & bypass
- Mounts off-line –
- No line restrictions
- All brass body with stainless steel piston and seat
- 14 oz weight

Part No.	Original No.	Description
8.712-628.0	462590	ST-230
8.701-626.0	087926	Repair Kit

ST-280 Regulator/Unloader



- 8 GPM
- 3600 PSI
- 175°F
- 27.5 oz weight
- Brass housing - stainless steel valve
- 3/8" FPT inlet/outlet
- 1/4" FPT bypass

Part No.	Original No.	Description
8.712-674.0	462680	ST-280
8.701-655.0	088536	Seat Repair Kit "D"
8.701-654.0	088535	Piston Seal Kit "C"
8.701-653.0	088534	Poppet Repair Kit

MG4000 Series Unloaders

"The world's best unloader value" with a choice of PSI: 1500, 3000 or 4500.

- Forged Brass Body
- 3/8" FPT inlet, outlet & bypass
- Auxiliary 1/4" outlet
- 10 GPM
- 200°F
- Up to 4500 PSI
- Can be panel mounted
- Pressure limit indicated with color coded ring

Part No.	Original No.	PSI	Color
Without Knob			
8.712-715.0	463108	1500	Yellow
8.712-718.0	463110	3000	Red
8.712-724.0	463114	4500	Black
With Knob			
8.712-716.0	463108K	1500	Yellow
8.712-719.0	463110K	3000	Red
8.712-725.0	463114K	4500	Black
8.704-567.0	111442	Repair Kit	



MG4000 with Microswitch



- Can be used as (NO) Normally Open or (NC) Normally Closed
- Use for time delay shut down or as burner control
- Up to 4500 PSI
- Panel mountable
- 15 Amp microswitch

Part No.	Original No.	Pressure	Color
8.712-717.0	463109K	1500 PSI	Yellow
8.712-720.0	463111K	3000 PSI	Red
8.712-714.0	463105K	3600 PSI	Blue
8.712-727.0	463115K	4500 PSI	Black

13 GPM Pressure Actuated Unloaders

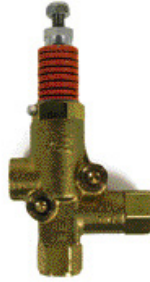

- 13 GPM
- 800-3000 PSI
- 160°F
- Bellville spring washers minimize spikes
- Forged brass bodies/ stainless ball & seat
- Four 1/4" side ports enhance versatility
- 1/2" FPT inlet, outlet & bypass ports
- 57.3 oz weight

Part No.	Original No.	Model No.	PSI	Spring
8.712-709.0	462934	22910	800	Silver
8.712-710.0	462935	22911	1400	Yellow
8.712-711.0	462937	22912	2400	Red
8.712-708.0	462933	22913	3000	Orange
8.722-137.0	G012099	Repair Kit		

Pressure Actuated Unloaders

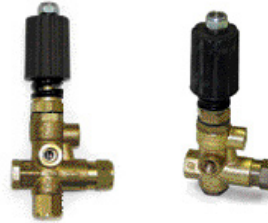

8.712-705.0 8.712-706.0

- Unloads pressure in entire system when in bypass
- Forged bronze body
- Stainless steel seat
- 3/8" FPT inlet/ 3/8" FPT outlet
- 1/4" FPT bypass
- 160°F

Part No.	Original No.	Model No.	GPM	PSI
8.712-705.0	462927	22760APM	8	3000
8.712-706.0	462928	22765APM	5	4000

Flow Actuated Unloaders



- Unloads pressure in entire system when in bypass
- Forged bronze body
- Stainless steel seat
- 3/8" FPT inlet/ 3/8" MPT outlet
- 1/2" bypass
- 160°F

Part No.	Original No.	Model No.	GPM	PSI
8.712-698.0	462909	22650	3.0-4.5	0-3000
8.712-701.0	462913	22654	3.5-4.8	3000-4000
8.712-702.0	462914	22655	4.5-5.5	0-3000
8.712-703.0	462915	22656	4.5-6.5	0-3000
8.722-204.0	G022666	Seal Kit		

UNLOADERS

AR Bolt On Unloaders

Mini-Matic Models.



- Fits XT and XM series pumps
- 2600 PSI rated pressure
- 1-2" F inlet
- 3/8" M Outlet

Part No.	Original No.	AR Model No.	GPM	Bypass
8.712-564.0	462228	AR20821	2-5	AL, No injector
8.712-573.0	462243	AR20890	2-3	AL, Adj injector
8.712-576.0	462246	AR21039	2-3	Brass, Adj injector
8.712-575.0	462245	AR21040	3-4	Brass, Adj injector
8.720-676.0	AR002812			Seal Kit

NOTE: AR has discontinued the Combiset unloaders. Use Mini-Mate unloaders as replacements. For 22mm twist coupler outlet models add SprayMart part# 331307 (3/8" x 22mm) to injector outlet.

Gymatic Unloaders



- RK & XM series pumps
- 3650 PSI rated pressure
- 3-5.5 GPM
- 3/8" M Outlet

Part No.	Orig No.	AR Model No.	Inlet
8.712-565.0	462229	AR20242	1/2" F w/ no injector
8.712-563.0	462226	AR20242G	3/4" (GHF) w/ no injector
8.712-574.0	462244	AR20081	1/2" M fixed injector #1 (2-3 gal)
8.712-567.0	462233	AR20082	1/2" M fixed injector #2
8.712-568.0	462235	AR20399	1/2" M adj injector #1 (2-3 gal)
8.712-569.0	462236	AR20400	1/2" M adj injector #2
8.720-642.0	AR002611		Repair Kit



- Max PSI: 4000
- Inlet: 1/2" M
- Bypass: Brass
- Max. GPM: 5
- Outlet: 3/8" M NPT
- Without Injector

Part No.	Orig No.	AR Model No.
8.712-583.0	462255	AR21669

- Max PSI: 4000
- Inlet: 1/2" F
- Bypass: Brass
- Max. GPM: 5
- Outlet: 3/8" M

Part No.	Orig No.	AR Model No.
8.720-903.0	AR20992	AR20992G

VS200 / 180 High Volume Regulator



- 53.5 GPM
- 2600 PSI
- 194°F
- 3/4" FPT inlet x 1/2" FPT bypass
- 29.4 oz weight

Part No.	Original No.	Description
8.712-753.0	463705	VS 200/180
8.704-582.0	111520	Repair Kit

VS350 Regulator / Relief Valve



- Rated pressure: 5100 PSI
- 5600 PSI
- 6.5 GPM
- 195°F
- 3/8" FPT inlet, outlet & bypass
- 16.8 oz weight

Part No.	Original No.	Description
8.712-756.0	463720	VS 350
8.704-611.0	111832	Repair Kit

VS 500 High Pressure Regulator / Relief Valve



- Rated pressure: 7250 PSI
- 8100 PSI
- 21 GPM
- 195°F
- Forged bronze body
- 1/2" FPT inlet & bypass
- 14.2 oz weight

Part No.	Original No.	Description
8.712-757.0	463725	VS 500

VS 220 Regulator / Relief Valve



6.3 GPM – 3600 PSI max pressure.



- Rated 3200 PSI
- 200°F
- Forged bronze body
- Stainless steel plunger & seat valve
- Two 3/8" FPT inlets
- 3/8" FPT outlet/bypass
- Compact design
- 14.2 oz weight

Part No.	Original No.	Description
8.712-737.0	463655	VS 220 w/o Knob
8.901-057.0	111576	Repair Kit

Safety Pressure Relief Valves



Engineered and built by Interpump. Premium quality valves for all pressure systems.



- Adjustable popoff protection
- Machined brass bodies
- Stainless steel plunger & seat
- 165°F
- 3/8" MPT connect x 1/4" MPT
- Bypass & outlet
- S - R: Safety Valve - 3000 PSI @ 1.3 to 10.8 GPM
- S - 3: Safety Valve - 500 to 10,000 PSI @ 2.6 to 26.5 GPM

Part No.	Original No.	Description
8.711-215.0	390103	S - R Valve
8.711-227.0	390123	S - 3 Valve

Timax Pressure Regulator Valve



- Max flow 52 GPM
- Max pressure 1000 PSI
- Lever control manual dump for bypass to relieve line pressure
- 3/4" & 1" FPT inlet & outlet
- 3/4" FPT bypass
- Brass body - SS piston & seat

Part No.	Orig. No.	Description
8.712-624.0	462580	Timax Reg Valve
8.702-844.0	103051B	Repair Kit

Regulating Relief Valve



Economical replacement for paraplate BR5 Series.



- 7 GPM
- Pressure adjusts 200-2000 PSI
- 200°F
- 3/8" FPT Inlet, outlet & bypass
- Flow-Thru design for smooth operation
- Machined brass body & knob
- Stainless steel plunger & seal

Part No.	Original No.	Description
8.712-625.0	462585	Relief Valve
8.900-042.0	075127	Repair Kit

Unloader Mounting Block



End vibration-caused fitting failure.



- 12 GPM
- Mounting hardware included
- Machine block brass

Part No.	Original No.	Description	PSI
8.904-568.0	462183X	3/8" x 3/8"	5500
8.904-567.0	462182X	1/2" x 1/2"	5500

Amerimax Injector



The Higher Rate Injector. Our Best Seller!



- Brass housing
- Stainless steel orifice
- Fully adjustable metering valve
- Stainless steel spring
- 3500 PSI
- 3/8" MPT inlet/outlet
- 1/4" hose barb

Part No.	Original No.	Description
Standard		
8.904-192.0	360130	"0", 1-2 GPM
8.904-193.0	360131	"1", 2-3 GPM
9.803-998.0	360132	"2", 3-5 GPM
8.904-194.0	360133	"3", 5-8 GPM
8.900-040.0	075122X	Repair Kit (SS check ball)

"Acid" Injector w/ Special Inlet Check Valve

8.904-201.0	360140X	"0A", 1-2 GPM
8.904-202.0	360141X	"1A", 2-3 GPM
8.904-203.0	360142X	"2A", 3-5 GPM
8.904-204.0	360143X	"3A", 5-8 GPM
8.900-041.0	075123X	Acid Repair Kit*

*(Ceramic check ball)

Quick-Coupled Amerimax



Assembled for Added Convenience - "Quick" couples to unloader outlet and "Quick" couples hose to injector outlet.



- Top-Quality quick-couplers: 3/8" plug inlet, 3/8" socket outlet
- 6' Industrial grade poly-braid reinforced tubing (will not collapse, resists crimping, high chemical tolerance)
- Heavy-duty brass chemical filter with check valve prevents loss of prime

Part No.	Original No.	Description
Amerimax "QC"		
8.904-195.0	360135X	Quick Coupled "0", 1-2 GPM
8.904-196.0	360136X	Quick Coupled "1", 2-3 GPM
8.904-197.0	360137X	Quick Coupled "2", 3-5 GPM
8.904-199.0	360138X	Quick Coupled "3", 5-8 GPM
8.900-040.0	075122X	Repair Kit (SS check ball)

Amerimax Acid "QC"

8.904-205.0	360145X	Quick Coupled "0A", 1-2 GPM
8.904-206.0	360146X	Quick Coupled "1A", 2-3 GPM
8.904-207.0	360147X	Quick Coupled "2A", 3-5 GPM
8.904-208.0	360148X	Quick Coupled "3A", 5-8 GPM
8.900-041.0	075123X	Acid Repair Kit*

*(Ceramic check ball)

INJECTORS

ST-64 Up Stream Injector



Apply soap at high pressure. Restricts waterflow to create suction.



- 140 PSI
- 160°F
- 3/4" FGH inlet
- 3/4" MGH outlet
- Chemical Strainer and 4' PVC Tubing included!
- Adjustable with ST-61 Meter Valve
- Locking waterflow adjustment

Part No.	Original No.	GPM
8.710-482.0	360155	1.5-4.0
8.710-483.0	360156	4.0-7.0

ST-62 Variable Chemical Injector



Flow Orifice Adjusts for Machines from 2-8 GPM. Requires ST-61 (below) to regulate Chemical Injection Rate.



- Forged brass body
- 3500 PSI
- 8 GPM

Part No.	Original No.	Description
8.710-485.0	360162	ST-62
8.701-648.0	088424	Repair Kit "F"

ST-61 Chemical Metering Valve



- Snap-on attachment to ST-60, ST-62, ST-261/I (usage limited to these injectors)
- Adjusts from "Off to Full" flow
- Glass-filled polyamide body & valve parts
- 1/4" hose barb
- Teflon® seals

Part No.	Original No.	Description
8.710-777.0	371161	ST-61

ST-60 Chemical Injector



Requires ST-61(above) to regulate chemical injection rate.



- Forged brass body
- Compact size Forged brass body
- Inlet 3/8" MPT
- Outlet 3/8" FPT

Part No.	Orig. No.	Description
8.710-476.0	360120	1.50 – 2.25, ST-60/0
8.710-477.0	360121	2.25 – 3.35, ST-60/1
8.710-478.0	360122	3.35 – 5.00, ST-60/2
8.701-648.0	088424	Repair Kit "F"

Robokim Chemical Injectors



- Forged brass body
- Stainless steel orifice
- Stainless steel inlet check valve components
- 3500 PSI
- 180°F
- 3/8" MPT inlet/outlet
- 1/4" hose barb

Part No.	Original No.	Model No., GPM
Robokim w/ Plastic Meter Knob		
8.710-497.0	360200	"0", 2.1-2.9
8.710-498.0	360201	"1", 3.0-4.0
8.710-499.0	360202	"2", 4.0-5.5
8.710-500.0	360203	"3", 5.5-10.8
Robokim w/ Brass Meter Knob		
8.904-213.0	360220	"0", 2.1-2.9
8.904-214.0	360221	"1", 3.0-4.0
8.904-215.0	360222	"2", 4.0-5.5
8.904-216.0	360223	"3", 5.5-10.8
8.900-481.0	103053X	Repair Kit
8.900-061.0	077010X	Acid Kit

Robokim Quick-Coupled Chemical Injectors



- Quick-Couplers: 3/8" QC plug inlet, 3/8" QC socket outlet
- 6' Industrial grade poly-braid reinforced tubing
- AP brass chemical filter w/ stainless steel check valve

Part No.	Original No.	Model No., GPM
Robokim "QC" w/ Plastic Knob		
8.904-209.0	360210X	"0", 2.1-2.9
8.904-210.0	360211X	"1", 3.0-4.0
8.904-211.0	360212X	"2", 4.0-5.5
8.904-212.0	360213X	"3", 5.5-10.8
Robokim "QC" w/ Brass Knob		
8.904-217.0	360230X	"0", 2.1-2.9
8.904-218.0	360231X	"1", 3.0-4.0
8.904-219.0	360232X	"2", 4.0-5.5
8.904-220.0	360233X	"3", 5.5-10.8

Hi-Lo Injector

May be used on high side or low side of pump. Adjustable flow orifices plus adjustable chemical valves. Standard features similar to ST-62.



- Performance Range Low side: .5-3.5 GPM @ 10-120 PSI High side: 2.0 - 8.0 GPM @ 3500 PSI
- Machined brass body
- 3/8" FPT inlet/outlet

Part No.	Original No.	Description
8.710-486.0	360163	Hi/Lo Injector w/ Meter Valve
8.710-487.0	360165	w/o Chemical Adjust
8.700-290.0	075136	Repair Kit
8.900-044.0	075136X	Seal Kit



400 Series Chemical Injectors

The Injector of choice.



Orifice Selection	
Orifice Dia.	Flow Rate
1.6mm	1.5-2.7 GPM
1.8mm	2.0-3.6 GPM
2.1mm	2.7-4.9 GPM
2.3mm	3.3-6.0 GPM

Adjustable Injectors, precise needle metering valve.

Orifice Size (mm)	M x M Part No	M x M Orig No	M x F Part No	M x F Orig No	F x M Part No	F x M Orig No
Brass						
1.6	8.710-541.0	360406	8.710-549.0	360416	8.710-559.0	360426
1.8	8.710-535.0	360400	8.710-543.0	360410	8.710-551.0	360420
2.1	8.710-537.0	360401	8.710-545.0	360411	8.710-554.0	360421
2.3	8.710-539.0	360402	8.710-547.0	360412	8.710-557.0	360422

Orifice Size (mm)	M x M Part No	M x M Orig No	M x F Part No	M x F Orig No	F x M Part No	F x M Orig No
Stainless Steel						
1.6	8.710-542.0	360406S	8.710-550.0	360416S	8.710-560.0	360426S
1.8	8.710-536.0	360400S	8.710-544.0	360410S	8.710-552.0	360420S
2.1	8.710-538.0	360401S	8.710-546.0	360411S	8.710-556.0	360421S
2.3	8.710-540.0	360402S	8.710-548.0	360412S	8.710-558.0	360422S

Part No.	Original No.	Description
Repair Kits include Check Ball, Spring, Seat & O-ring		
8.900-769.0	109220X	Standard Kit

- Teflon® valve seat
- 3/8" inlet & outlet (3 configurations)
- Forged brass housing
- 3200 PSI
- Renewable orifices & check valve
- 200°F
- Options include: quick-coupled, stainless steel orifices/ acid-resistant check
- Only 5 oz weight

Orifice Size (mm)	M x M Part No	M x M Orig No	M x F Part No	M x F Orig No	F x M Part No	F x M Orig No
Brass/Acid-Resistant						
1.6	8.904-230.0	360406A	8.904-238.0	360416A	-	-
1.8	8.904-224.0	360400A	8.904-232.0	360410A	8.904-240.0	360420A
2.1	8.904-226.0	360401A	8.904-234.0	360411A	8.904-242.0	360421A
2.3	8.904-228.0	360402A	8.904-236.0	360412A	8.904-244.0	360422A

Orifice Size (mm)	M x M Part No	M x M Orig No	M x F Part No	M x F Orig No	F x M Part No	F x M Orig No
Stainless Steel/Acid-Resistant						
1.6	8.904-231.0	360406AS	8.904-239.0	360416AS	8.904-246.0	360426AS
1.8	8.904-225.0	360400AS	8.904-233.0	360410AS	8.904-241.0	360420AS
2.1	8.904-227.0	360401AS	8.904-235.0	360411AS	8.904-243.0	360421AS
2.3	8.904-229.0	360402AS	8.904-237.0	360412AS	8.904-245.0	360422AS

Part No.	Original No.	Description
Repair Kits include Check Ball, Spring, Seat & O-ring		
8.900-770.0	109222X	Acid Kit

Series 505 Stainless Steel

All metal parts are Stainless Steel.



- Premier type injector
- 3200 PSI
- 3/8" inlet/outlet
- 190°F



Part No.	Original No.	Description	GPM
8.710-586.0	360505/1.8	SS Injector 1.8	2.0 - 3.6
8.710-587.0	360505/2.1	SS Injector 2.1	2.7 - 4.9
8.710-588.0	360505/2.3	SS Injector 2.3	3.3 - 6.0
8.704-027.0	109234	Repair Kit	

Brass Injectors

All metal parts are Brass.



- Premier type injector
- 3200 PSI
- 3/8" inlet/outlet
- 190°F



Part No.	Original No.	Description	GPM
8.710-505.0	360245	Brass Injector 1.8	2.0 - 3.6
8.710-506.0	360246	Brass Injector 2.1	2.7 - 4.9
8.710-507.0	360247	Brass Injector 2.3	3.3 - 6.0
8.704-028.0	109235	Repair Kit	

Adjustable Quick-Connect Injector



- 3500 PSI
- 200°F

Part No.	Original No.	GPM
8.710-502.0	360240	2-3
8.710-503.0	360242	3-5
8.710-504.0	360244	5-8

Part No.	Original No.	Description
Acid Injectors		
8.904-221.0	360240A	2-3
8.904-222.0	360242A	3-5
8.904-223.0	360244A	5-8
8.701-187.0	080055	Injector Repair Kit
8.900-087.0	080056	Injector Acid Kit

Exact-A-Flow Pressure Reducer / Injector

"Low side" chemical injector that regulates inlet pressure to maintain consistent chemical ratio.



- Up to 6 GPM
- 1/2" FPT I/O ports
- 1/4" hose barb chemical inlet
- ± 2% injection ratio variation

Part No.	Original No.	Description
8.711-162.0	385127	Weep Seat*
8.711-160.0	385125	Non-Weep
8.711-161.0	385126	With Switch**
8.904-389.0	385128	Hose Barb w/ Viton Check
8.904-390.0	385129	Hose Barb w/ Buna Check

*Weep Seat allows pump to self-prime
**With burner control switch automatically turns burner off when water flow stops

INJECTORS

Adjustable Bronze Float Valves



- Cast bronze body
- Live rubber stopper
- Adjustable float arm
- 180°F

Part No.	Original No.	Thread	Stem	GPM @ 40 PSI
8.710-041.0	343300	3/8"	1/4" – 20	10
8.710-043.0	343302	1/2"	1/4" – 20	17
8.710-044.0	343304	3/4"	1/4" – 20	31
8.710-045.0	343306	1"	1/4" – 20	47

NOTE: Float valves above require stem & float, below

Repair Parts for Adjustable Valves

8.700-475.0	076406	Long Arm*
8.700-476.0	076407	Short Arm*
8.700-477.0	076408	Thumb Screw*
8.700-479.0	076418	3/8" & 1/2" Plunger
8.700-480.0	076420	3/4" Plunger
8.700-481.0	076422	1" Plunger

*Fits 3/8", 1/2" & 3/4" Valve Only

Stems Only



9.802-157.0



8.710-047.0

Part No.	Original No.	Length	Material	Thread
9.802-157.0	343310	8"	Brass	1/4" – 20
8.710-047.0	343310C	8"	Brass	1/4" – 20 x 5/16" – 18
8.710-048.0	343311	8"	Brass	5/16" – 18
8.710-051.0	343315	10"	Brass	1/4" – 20
8.710-049.0	343313B	18"	Brass	3/8" – 16
8.740-042.0	343316	19"	Brass	1/2" – 20

Parts for other float valves also available

Copper & Plastic Float Balls



8.710-053.0



8.710-054.0



9.802-061.0

Part No.	Original No.	Length	Material	Thread
8.710-061.0	343326	4" x 5"	Copper	1/4" – 20
8.710-052.0	343317	5"	Copper	1/4" – 20
8.710-053.0	343318	6"	Copper	1/4" – 20

Plastic

8.710-054.0	343319	4-1/2"	Plastic	1/4" – 20
8.710-055.0	343320	5"	Plastic	1/4" – 20
8.710-057.0	343321	6"	Plastic	1/4" – 20
8.710-058.0	343322	6"	Plastic	5/16" – 18
8.710-059.0	343323	8"	Plastic	1/4" – 20
9.802-061.0	343325	4" x 5"	Plastic	1/4" – 20

Parts for other float valves also available

PA Float Valve



- 140°F
- 3/8" BSP inlet
- Brass body
- Positional/Adjustable arm
- 5 GPM @ 15 PSI
- 7 GPM @ 30 PSI

Part No.	Original No.	Description
8.710-042.0	343301	3/8" Float Valve
8.704-204.0	110250	Repair Kit

Brass Float Valve Assembly



COMPLETE: Valve, Stem & Float



- 1/2" FPT inlet
- Brass housing with polyamide cover
- 4.5 GPM
- 175°F

Part No.	Original No.	Description
8.710-031.0	343010	ST-8
8.701-558.0	085331	Repair Kit

MPT Adapter Kit for ST-8*

8.710-033.0	343012
-------------	--------

*Double MPT nipple, sealing washer & lock nut

Brass Float, Ball & Stem



- 142 PSI max inlet pressure
- 140°F
- 7.1 GPM @ 28 PSI - 1/2" MPT inlet
- Positive soft Buna/brass shut-off
- Adjustable float ball settings
- Inlet nut and washer seal provided

Part No.	Original No.	Description
8.710-037.0	343050	Valve Complete
8.704-092.0	109502	Repair Kit

Diaphragm Float Valve



- Requires only 6.5" x 3" inside tank
- All plastic snap-on float
- Positive shut off diaphragm style
- Inlet screen, tank gasket & nut included
- Rebuildable – repair parts available
- 3/4" MPT inlet
- 142 PSI
- 7.86 GPM @ 28 PSI
- 6.68 GPM @ 14 PSI
- 140°F

Part No.	Original No.	Description
8.710-030.0	343007	Float Valve Complete

Hudson Float Valve



- No external moving parts
- No float ball or arm
- Operates between 0-130 PSI
- All plastic, nylon, rubber & stainless steel
- 90°F
- 1" inlet - easy installation
- Automatic anti-siphon
- Flow capacity 80% of supply (40 GPM @ 40 PSI)

Part No.	Original No.	Description
8.710-035.0	343022	1" Hudson Float Valve, 90°
8.710-036.0	343026	1" Hudson Float Valve, 150°

Kerick Float Valve



- Flow rates for 1/2" Valve:
- 20 PSI: 7.7 GPM
 - 30 PSI: 9.1 GPM
 - 40 PSI: 10.5 GPM
 - 50 PSI: 11.4 GPM
 - 60 PSI: 12.5 GPM
- Flow rates for 3/4" Valve:
- 30 PSI: 13 GPM
 - 60 PSI: 16.5 GPM

Part No.	Description
8.749-328.0	1/2" Float Valve, .25" orifice
8.749-329.0	3/4" Float Valve, .30" orifice

Check Valves - Swing Action

Retain prime on pumps with low lift capability



- Brass body with swing (flapper) action
- 150 PSI
- FPT inlet/outlet
- Gravity seal – no spring pressure

Part No.	Original No.	Description
8.709-378.0	310862	1/2"
8.709-379.0	310863	3/4"
8.709-380.0	310864	1"
8.709-381.0	310865	1-1/4"
8.709-382.0	310866	1-1/2"
8.709-383.0	310868	2"

Stainless Steel Check Valves



- Rated pressure: 5800 PSI
- 6500 PSI
- 195°F
- Female x Female
- 2.0 oz weight

Part No.	Original No.	Description	Flow Rate
8.709-361.0	310827	1/4" F x F,	6.1
8.709-362.0	310828	3/8" F x F,	10.5



High Pressure Check Valves

2500 or 3000 PSI ball check.



- Buna seals
- Stainless steel check ball
- Machined brass body
- 1 PSI cracking pressure

Part No.	Original No.	Description
2500 PSI Miniature Ball Check		
8.709-356.0	310814	1/4", M x F
8.709-357.0	310815	1/4", M x M

Part No.	Original No.	Description
3000 PSI Stainless Guided Ball & Quad Ring Seat		
8.709-358.0	310820	1/4", F x F
8.709-359.0	310822	3/8", F x F

Check Valves - 1200 PSI

Allows excellent low-restriction flow in inlet direction and instant positive check action in reverse direction.



- Machined brass body
- Poppet seal
- Cracking pressure 1 PSI

Part No.	Original No.	Description
8.709-351.0	310804	1/4", F x F
8.709-352.0	310806	3/8", F x F
8.709-353.0	310808	1/2", F x F
8.709-354.0	310811	3/4", M x M

Brass Check Valves - Spring-Loaded

Holds pump prime without overloading pump suction.



- Machine cast brass bodies, FPT x FPT
- 150 PSI
- 250°F
- Mount horizontal or vertical

Part No.	Original No.	Description
8.709-384.0	310872	1/2"
8.709-385.0	310873	3/4"
8.709-386.0	310874	1"

Back Flow Preventor - Check Valve

Protects water supply from harmful chemical backflow – will not allow “spike” pressure to push chemicals into supply line. Now required by many city and state regulations



- 3/4" female garden hose inlet (with lock screw)
- 3/4" male garden hose outlet
- Machined brass housing
- Plastic diaphragm check

Part No.	Original No.	Description
8.705-039.0	140060	Back flow Preventor

VALVES

PVC Check Valve

Holds pump prime without overloading pump suction.

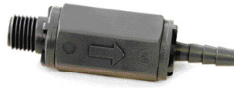

- Designed for harsh chemical applications
- PVC plastic body
- Stainless steel ball check
- Cracking press 1 PSI
- Choice of connects
- 125 PSI
- 180°F

Part No.	Original No.	Description
8.709-366.0	310834	1/4" MPT x 1/4" Barb
8.709-367.0	310835	1/4" Barb x 1/4" MPT
8.709-369.0	310837	1/4" Barb x 1/4" Barb
8.709-370.0	310838	3/8" Barb x 3/8" Barb
8.709-373.0	310844*	1/2" Barb x 1/2" Barb

*8.709-373.0 has viton seals

Stainless Steel Ball Valves - 2000 PSI



- Full flow ports
- Investment cast process
- Two piece 316 Stainless bodies
- Glass-filled Teflon[®] seals
- 180°F @ 2,000 PSI
- 300°F @ 1,000 PSI
- 350°F @ 300 PSI

Part No.	Original No.	Description
8.709-265.0	306534	1/4" F x F
8.709-266.0	306536	3/8" F x F
8.709-268.0	306538	1/2" F x F
8.709-269.0	306540	3/4" F x F

Forged Brass Ball Valves



- 600 PSI
- 180°F
- Forged brass body
- Full flow ports
- Teflon PTFE seals

M x F Part No.	F x F Part No.	M x M Part No.	Size
8.709-249.0	8.709-250.0	8.709-251.0	1/4"
8.709-252.0	8.709-253.0	8.709-254.0	3/8"
8.709-255.0	8.709-256.0	8.709-257.0	1/2"
8.709-258.0	8.709-259.0	8.709-260.0	3/4"
8.709-261.0	8.709-262.0	8.709-263.0	1"

Nickel-Plated Brass Ball Valves



- Threaded FPT connects
- Chrome-plated ball
- Seats & seals have glass-filled Teflon[®]
- Full flow bore

Part No.	Original No.	Description	Working Pressure (PSI)
8.709-242.0	306504	1/4"	710
8.709-243.0	306506	3/8"	710
8.709-244.0	306508	1/2"	710
8.709-245.0	306512	3/4"	570
8.709-246.0	306516	1"	570
8.709-247.0	306520	1-1/4"	430
8.709-248.0	306524	1-1/2"	430
8.709-264.0	306532	2"	360

Mini Ball Valves



- Forged brass body
- 600 PSI
- 180° handle movement

M x F Part No.	F x F Part No.	M x M Part No.	Size
8.709-208.0	8.709-209.0	-	1/8"
8.709-211.0	8.709-212.0	8.709-213.0	1/4"
8.709-216.0	8.709-217.0	8.709-218.0	3/8"

High Pressure Ball Valves



- Rugged carbon steel construction
- 2-way
- NPT (F x F) threads
- Blow-out proof stems
- Delrin ball seats
- Viton O-rings

Part No.	Original No.	FPT	PSI
8.709-274.0	306552	1/4" x 1/4"	7350
8.709-276.0	306553	3/8" x 3/8"	7350
8.709-279.0	306554	1/2" x 1/2"	7350
8.709-282.0	306556	3/4" x 3/4"	5880
8.700-270.0	075080	Replacement handle - fits all sizes above	
8.700-271.0	075089	Replacement screw for handle	

Stainless Steel High Pressure Ball Valves - 5800 PSI

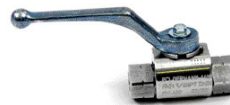

- 316 Stainless steel body, ball & stem
- Viton O-rings
- Delron ball seats
- Full Port

Part No.	Original No.	FPT	PSI
8.709-277.0	306553S	3/8" x 3/8"	5880
8.709-280.0	306554S	1/2" x 1/2"	5880
8.709-283.0	306556S	3/4" x 3/4"	5880
8.709-286.0	306558S	1" x 1"	5880

Stainless Steel One Piece Ball Valves - 800 PSI



- Standard port
- 316 Stainless steel body
- 300°F @ 800 PSI
- 350°F @ 400 PSI
- Suitable for steam

Part No.	Original No.	FPT
8.709-287.0	306582	1/4" x 1/4"
8.709-288.0	306583	3/8" x 3/8"
8.709-289.0	306584	1/2" x 1/2"
8.709-290.0	306585	3/4" x 3/4"

Brass Mini Ball Valves



- Compact knob operation
- Brass housing-hex bar
- 220 PSI working pressure
- Designed to fit tight quarters
- Teflon[®] seals
- Only 1-3/4" long

Part No.	Original No.	FPT
8.709-270.0	306542	1/8" x 1/8"
8.709-271.0	306544	1/4" x 1/4"
8.709-272.0	306546	3/8" x 3/8"
8.709-273.0	306548	1/2" x 1/2"

PVC Ball Valves

Great for chemical On/Off flow control.



- PVC & nitrile material
- Chemical & impact resistant
- Flag handle
- 180°F
- 125 PSI

Part No.	Original No.	Description
8.709-214.0	306352P	1/4" Panel Mtg, Barb x Barb
8.709-219.0	306354P	1/4" Inline, Barb x Barb
8.709-220.0	306356	3/8" Inline, Barb x Barb

Polypropylene Ball Valves

Full port reinforced polypropylene.



8.709-222.0

8.709-228.0

- 150 PSI working pressure
- Easy turn w/ Telflon® seals
- Double seal in stem for "no leak"
- Threaded mounting bosses, brass insert on 1-1/4" - 2" sizes

Part No.	Original No.	FPT
Two-Way Ball Valves		
8.709-222.0	306390	1/2" x 1/2"
8.709-223.0	306392	3/4" x 3/4"
8.709-224.0	306394	1" x 1"
8.709-225.0	306398	1-1/2" x 1-1/2"
8.709-226.0	306400	2" x 2"

Part No.	Original No.	FPT
Three-Way Ball Valves		
8.709-227.0	306408	1/2" x 1/2" x 1/2"
8.709-228.0	306412	3/4" x 3/4" x 3/4"
8.709-229.0	306416	1" x 1" x 1"
8.709-230.0	306420	1-1/4" x 1-1/4" x 1-1/4"
8.709-231.0	306422	1-1/2" x 1-1/2" x 1-1/2"
8.709-232.0	306424	2" x 2" x 2"

Compact PVC Ball Valves



- FPT thread both ends
- 150 PSI working pressure
- Easy turn handle
- 150°F
- EPDM seals - white body

Part No.	Original No.	FPT
8.709-233.0	306444	1/4" x 1/4"
8.709-234.0	306448	1/2" x 1/2"
8.709-235.0	306450	3/4" x 3/4"
8.709-236.0	306452	1" x 1"
8.709-237.0	306454	1-1/4" x 1-1/4"
8.709-238.0	306456	1-1/2" x 1-1/2"
8.709-239.0	306460	2" x 2"

3-Way Ball Valve



- 400 PSI maximum pressure
- 180°F maximum temperature
- Teflon seat
- Buna seals
- Brass

Part No.	Original No.	Description
8.709-207.0	306331	1/4" M x F x F

Flow Selector Valve



3-way & 4-way lever control with brass body.

- 3-way
Plumb for 2 inlets & 1 outlet or 1 inlet & 2 outlets
- 4-way
Plumb for 3 inlets & 1 outlet or 1 inlet & 3 outlets
- 180°F rated temperature

Part No.	Original No.	Description
8.710-108.0	343734	1/4" FPT 3-Way
8.710-110.0	343736	3/8" FPT 3-Way
8.710-113.0	343744	1/4" FPT 4-Way
8.710-114.0	343746	3/8" FPT 4-Way

Flow Control Metering Valve



- Forged brass, nickel-plated body
- Panel mtg in 17/32" hole
- Compact size
- Double stem seal
- 300 PSI
- 175°F rated temperature

Part No.	Original No.	Description
8.710-775.0	371125	1/4", FPT In/out
8.710-776.0	371133	3/8", FPT In/out

Flow Control Metering Valve



The Valve that "Seals" (will not suck air).



- 3500 PSI to 28" vacuum - No leak
- Viton gland seal isolates metering threads from solution
- Stainless steel needle/brass seat
- 1/4" FPT ports
- Heavy-duty brass bar stock body
- 195°F rated temperature
- Panel mounts 5/8" hole
- Large easy-grip four-lobe handwheel
- Aluminum or Poly available

Part No.	Original No.	Description
8.904-362.0	371120X	Metering Valve / Alum Knob
8.904-361.0	371120P	Metering Valve / Poly Knob
8.740-083.0	077003A	Replacement Knob

Brass Metering Valve

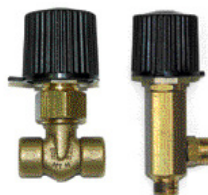

- Easy grip, fluted plastic handle with pointer
- Brass body, Viton gland seal eliminates air leaks
- Panel mount 11/16" or 3/4" hole
- Extremely compact T-style
- 1/4 inlet/outlet
- 450 PSI
- 170°F

Part No.	Original No.	Description
8.710-773.0	371115	"T" 1/4 F x F - Forged
8.710-774.0	371116	"L" 1/4 M x M - Machined

VALVES

Chemical Metering Valves



9.802-187.0

- Adjusts from off to full flow
- 4000 PSI
- 1/4" FPT Inlet - Outlet
- 6 GPM
- 2-30151 has presettable limiting orifice

Part No.	Orig. No.	Description
8.710-771.0	727628	Flow Control
9.802-187.0	2-30151	Flow Control w/ Locking Adjustment

Chemical Metering / On-Off Valve



- Dual knob control – Calibrate chemical flow w/base knob. Outside knob allows on/off control without changing calibration
- Single (1/2") hole panel mounting
- Brass & stainless steel materials

Part No.	Original No.	Description
8.710-770.0	371100	MV-100

ST-66 Chemical Meter & Selection Valve



- Two input barbs – for different chemicals to single outlet barb
- Double metering dial with center OFF
- Panel mount in single 5/8" hole

Part No.	Original No.	Description
8.710-779.0	371166	ST-66

Steam Valve

For "Combo" Hot Pressure Washer/Steamer Units. The single turn on/off diverter valve by-passes pump flow to reduce water flow to the coil, creating steam in place of normal hot water.



- Panel mount in 11/16" or 3/4" hole
- Machined brass body
- Easy-grip plastic knob
- 3600 PSI
- 175°F
- 1/4" MPT inlet/outlet

Part No.	Original No.	Orifice (mm)
8.711-263.0	400008	0.8
8.904-406.0	400012	1.2
8.904-407.0	400015	1.5
8.904-408.0	400018	1.8
8.904-409.0	400020	2.0

Compact Thermal Relief Valves

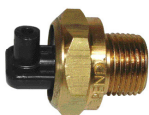

- 145°F "Trip" temperature

Part No.	Original No.	Size	"Trip" Temp
9.802-181.0	921421	3/8" MPT	145°F

Thermal Relief Valves



A MUST for any pump that might ever be left in bypass mode (unloading) for more than 15 seconds! Protects the pump from overheating caused by recirculating water.



- Installs in bypass line
- Automotive style wax element
- Automatically resets at cool down to 115°+ F
- No adjustment required
- 1/8" FPT side discharge
- 125 PSI inlet pressure
- 2.5 GPM flow

Part No.	Original No.	Inlet	"Trip" Temp
8.904-564.0	458000	1/4" MPT	140°F
8.904-565.0	458001	3/8" MPT	140°F
8.904-566.0	458005	1/2" MPT	140°F
8.723-943.0	458007	1/2" MPT	165°F

Compact Thermal Relief Valves



- 145°F "Trip" temperature

Part No.	Original No.	Size	"Trip" Temp
8.712-544.0	458024	1/4" MPT	145°F
8.712-545.0	458026	3/8" MPT	145°F
9.802-182.0	458028	1/2" MPT	145°F

TRV Thermal Relief Valves

Low Profile!

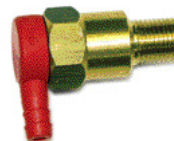

- Brass body
- Plastic covered barb
- 7mm Hose barb
- 145 PSI
- Opens at 145°

Part No.	Original No.	Inlet
8.712-546.0	458030	1/4"
8.712-547.0	458032	3/8"
8.712-548.0	458034	1/2"

Flow Meters



The answer to precision calibration and efficient operation of pressure washing systems.



- Flow scale measures gallons per hour (GPH)
- 100 PSI
- 150°F
- 1/8" FPT inlet & outlet port
- Wetted parts are brass or stainless steel, with or without metering values
- Accurate within ±5%
- Precision cut and machined clear acrylic
- Metal mounting inserts for ease of installation (10-32 threads)
- Compact size – 2" tall scale, 4-3/32" overall height

Part No.	Original No.	GPH	Metal	Metering Valve
8.710-097.0	343722	.6 – 5	Brass	no
8.710-098.0	343723	.6 – 5	Brass	yes
8.710-101.0	343726	2 – 10	Brass	no
8.710-102.0	343727	2 – 10	Brass	yes
8.710-099.0	343724	.6 – 5	SS	no
8.710-100.0	343725	.6 – 5	SS	yes
8.710-104.0	343728	2 – 10	SS	no
8.710-105.0	343729	2 – 10	SS	yes

NOTE: All flow measurements must be on Low Pressure side of pump.

Rupture Disks



- Prevents dangerous thermal expansion of water in the coil
- Ensures operator safety

Part No.	Original No.	Description
9.802-192.0	2-3409	Assembly, 7000 PSI
8.707-381.0		Assembly, 8500 PSI

Safety Pressure Relief Valves



- Prevents pressure overloads, protecting people and equipment
- Machined brass
- Automatically resets

Part No.	Original No.	Max PSI	Size
8.722-192.0	G022550A	1200 (Silver Spring)	1/4"
8.722-193.0	G022560A	2400 (Red Spring)	1/4"
8.722-194.0	G022565A	3600 (Orange Spring)	1/4"
8.722-190.0	G022532A	3600 (Orange Spring)	3/8"
9.802-191.0	G022533A	5000 (Blue Spring)	3/8"

Air Valve - Coil Blow Out

Install inline in front of coil and use air pressure to blow water out of coil to prevent "Freeze Up".



- Threaded connection
- 1/4" brass valve
- 1/8" model is stainless steel
- Valve cap included

Part No.	Original No.	Description
8.705-047.0	140073	1/8" Stainless Steel Connect
8.705-048.0	140075	1/4" Connect
8.902-426.0		Valve Assy, Water Blow-Out
8.707-314.0		Valve Assy, Water Tank Blow-Out

Easy Start Valve

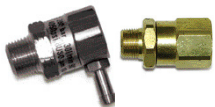

- 3/8" MPT inlet
- Hose barb outlet
- 1/8" FPT outlet
- Stainless steel internal
- Machined brass housing
- 200°F
- 8 GPM

Part No.	Original No.	Description
8.709-865.0	339004	Easy Start Valve, 4100 PSI
8.709-866.0	339005	Easy Start Valve, 3500 PSI
8.751-265.0		Valve, 5/16" HB Outlet, 5000 PSI
9.802-137.0	140352	Hose Barb, 1/8" x 1/4" Barb

Easy Start Valve



- 3/8" MPT inlet
- Hose barb outlet (8 mm)
- Machined brass body
- Stainless steel spring & ball
- 3200 PSI
- 176°F
- 7.8 GPM

Part No.	Original No.	Description
8.709-867.0	339006	Easy Start Valve

Steel Utility Gauges

Dry Gauges!



- Black lacquered steel case
- Bronze bourdon tube
- Dry gauge
- 1/4" NPT brass mounting stem
- Accuracy ± 3-2-3%

Part No.	Original No.	Pressure Range
2" bottom mount		
8.710-307.0	348552	0-60 PSI
8.710-308.0	348554	0-100 PSI
8.710-309.0	348558	0-200 PSI
8.710-310.0	348560	0-300 PSI

Fuel Oil Pressure Gauge



- 0-200 PSI
- Perfect for testing burner pump fuel pressure

Part No.	Original No.	Pressure Range
8.700-738.0	079020	0 - 200 PSI

Corrosion-Resistant ABS Gauge



- Acid & alkali proof plastic case
- Bronze bourdon tube
- 1/4" NPT brass mounting stem
- Accuracy Dry: ±3-2-3% Filled: ±1.5%

Part No.	Original No.	Pressure Range
8.710-291.0	348305	0-100 PSI
8.710-293.0	348307	0-200 PSI
8.710-294.0	348308	0-300 PSI
8.710-295.0	348312	0-1000 PSI
8.710-296.0	348313	0-2000 PSI
8.710-297.0	348314	0-3000 PSI
8.710-299.0	348316	0-5000 PSI

Pressure Gauge Kit



- 5000 PSI Cold Water
- 1-3/4" gauge
- 3/8" QC Socket
- 3/8" QC plug

Part No.	Description
8.712-208.0	Pressure Gauge Kit

GAUGES

Stainless Steel Pressure Gauges



- AISI 304 stainless steel case
- Bronze bourdon tube
- 99.5% pure glycerin filled
- PSI & Bar dual scale
- 1/4" NPT brass mounting stem
- Convex magnifying lens for easy reading
- Steel needle & peg
- Accuracy $\pm 1.5\%$

Part No.	Original No.	Pressure Range
2-1/2" Bottom Mount with Bronze Internals		
8.710-270.0	348216	0-100 PSI
8.710-272.0	348220	0-200 PSI
8.710-273.0	348224	0-300 PSI
8.710-276.0	348230	0-500 PSI
8.710-278.0	348240	0-1000 PSI
8.710-280.0	348245	0-2000 PSI
8.710-281.0	348250	0-3000 PSI
8.710-283.0	348255	0-4000 PSI
9.804-017.0	348260	0-5000 PSI
8.710-286.0	348262	0-6000 PSI
9.804-001.0	348265	0-10,000 PSI
2-1/2" Back Mount with Bronze Internals		
8.710-246.0	348125	30Hg - 0 Vacuum
8.710-250.0	348140	0-100 PSI
8.710-254.0	348150	0-500 PSI
8.710-256.0	348152	0-1000 PSI
8.710-257.0	348154	0-2000 PSI
8.710-258.0	348156	0-3000 PSI
8.710-259.0	348158	0-4000 PSI
9.803-996.0	348160	0-5000 PSI
8.710-262.0	348162	0-6000 PSI
9.804-013.0	348165	0-10,000 PSI
Mounting Hardware for Back Mount Gauges		
8.710-223.0	348001	U-bracket
8.710-228.0	348090	3-hole flange, mounted

AMP Meters



- Designed for OEM or replacement
- Utilize as constant monitor or as test instruments
- Accuracy to $\pm 5\%$
- Rugged & weather-resistant
- Bright stainless bezel
- Metal case
- Fits 2-1/16" mounting hole

Part No.	Original No.	Range
8.701-686.0	091321	-15 to +15 Amps
8.701-687.0	091323	-20 to +20 Amps
8.701-688.0	091344	-60 to +60 Amps

Hour Meters for Gasoline Engines



- Elapsed time & tamperproof
- No battery required
- Digital quartz accuracy ($\pm .02\%$)
- Extremely rugged
- Sealed from dirt & moisture
- Requires 2" panel cutout

Part No.	Description
8.749-183.0	EL 5-80V AC/DC 50/60 Hz
8.749-316.0	EL 24-277 AC/DC 50/60 Hz
9.802-283.0	115/240 VAC - Rectangle

Speedmaster Throttle Control



Stop overworking the engine and pump during bypass. Decelerator reduces engine speed when pump head pressure drops below 215 PSI, reduces flow during bypass, slows recirculation heat buildup.



- 3500 PSI
- 300°F
- A major system saver for gas engine units
- Machined brass body
- Stainless steel gland components
- 1/4" Male Connect
- Viton seals
- 42" lined and covered control cable
- Engine speeds infinitely adjustable for "Fine Tuned" system performance

Part No.	Original No.	Description
8.903-840.0	339000A	Throttle Control

Temperature Gauges



(Dial Thermometers)



- 3" diameter dial – stainless steel case
- Shatter-resistant polycarbonate lens
- Stainless steel stem (2.5")
- 1/2" MPT connector
- Accuracy to within 3% of dial range (ie. 50 - 500 = $\pm 6.8^\circ\text{F}$)

Part No.	Original No.	Description
8.712-488.0	426410*	Temp Gauge +50° to 500°F

*"Thermowell" to be used with dial thermometers in systems over 300 PSI. For best results fill thermowell with liquid silicon or glycol to increase sensitivity and accuracy of readings.

Thermowell for temperature gauge above

- Stainless Steel 3/4" MPT x 1/2" FPT
- Gives 2000 PSI collapse protection
- 1.75" immersion length

Part No.	Original No.	Description
8.712-489.0	426423	Thermowell for 426410 above

Pressure & Temperature Test Set



Convenient test set provides both pressure and temperature check with one easy quick coupled connection at outlet of unloader or coil.



- Test Set 5000 500°F Thermometer 5000 PSI pressure gauge for systems up to 2000 PSI
- Test Set 10,000 10,000 PSI pressure gauge for systems up to 5000 PSI

Part No.	Original No.	Description
8.904-559.0	449045	Test Set 5000 (0-2500 PSI systems)
8.904-558.0	449040	Test Set 10,000 (0-5000 PSI systems)